

# STREX MODULE

INSTALLATION INSTRUCTIONS | AUGUST 2020

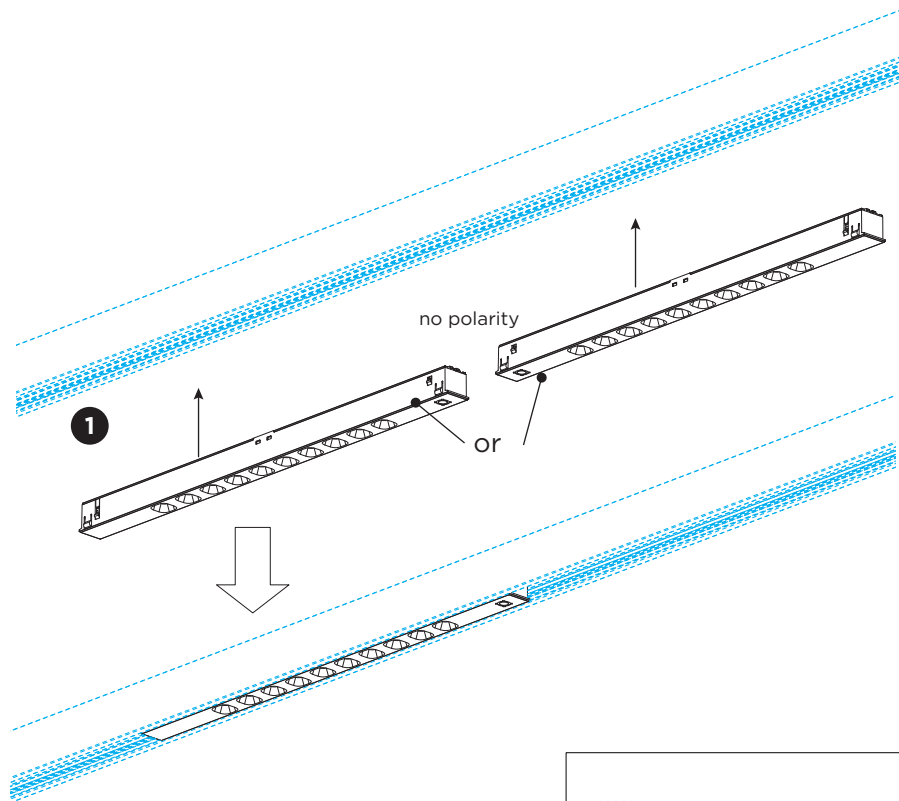

cross-section of track

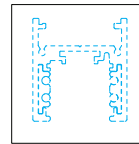

cross-section of track

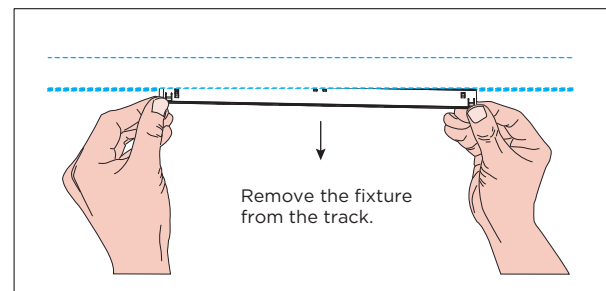
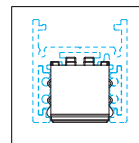

## DIMENSIONS

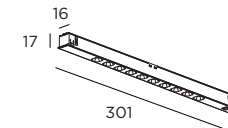

1.0 DOT

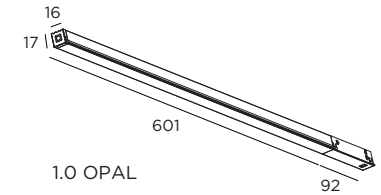

1.0 OPAL

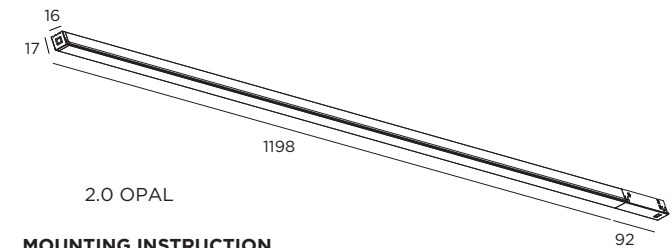

2.0 OPAL

## MOUNTING INSTRUCTION

- 1 Push the fixture into the track at the preferred location.



Note: the fixture is not allowed to slide in the track. If you want to change the location of the fixture in the track, please pull the fixture out of the track and install it in the correct position.

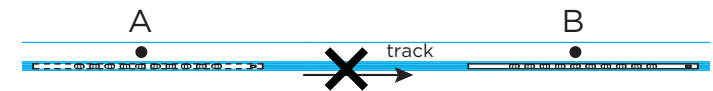

PB19-010-693-00\_V0