

SOLID

25-May-2019

1.0 LED

LED 8W | 220-240VAC | 50-60Hz | COB 3-step |incl. PS | phase-cut dim

CE IP20 0,9m 36° 25°/25° 355°

white texture	133164W
white texture + gold	133164J
black texture + gold	133164K
copper +black texture	133164P
black texture	133164B
bronze+black texture	133164Q

LIGHT COLOUR

2700K >90CRI 470lm	3
3000K >90CRI 470lm	5
1800-2850K >95CRI 410lm	9

1.0 PAR16

PAR16 max. 12W | GU10 | 100-240VAC | 50-60Hz

CE IP20 0,9m 25°/25° 355°

white texture	133120W0
white texture + gold	133120J0
black texture + gold	133120K0
copper +black texture	133120P0
black texture	133120B0
bronze+black texture	133120Q0

OPTIONAL

for PAR16 lamps see our catalogue

base plate dimensions

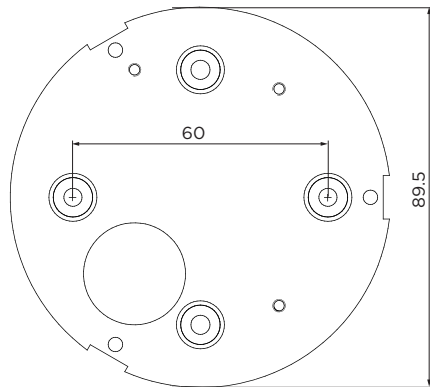

1.0 LED

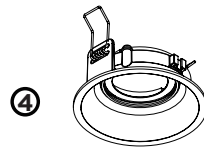
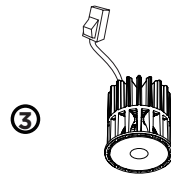
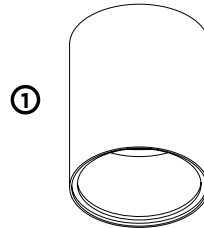

1.0 PAR16

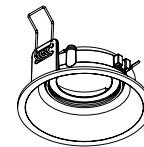
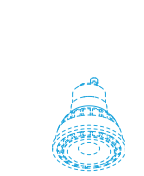
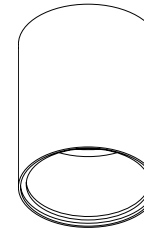

DIMENSIONS



1.0 LED



1.0 PAR16

1 MOUNTING INSTRUCTION

Attach the SOLID base plate to the ceiling with screws.

2 POWER CONNECTION

Connect to power
Interior connection : standard version

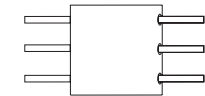

3 Insert the light module (PAR16/LED ENGINE) into the module and fix with spring.

4 Click the module into the SOLID base fixture with the springs.



WEVER & DUCRÉ
LIGHTING

www.weverducre.com

Wever & Ducre bvba Spinnerijstraat 99/21 8500 Kortrijk

**INSTALLATION
INSTRUCTIONS**