

DOCUS

17-Dec.-2016

1.0 LED

LED 8W | 220-240VAC | 50-60Hz | COB 2-step | incl. PS | phase-cut dim

CE IP20 0.3m 36°

white texture	146364W
aluminium brushed	146364L
gold	146364G
copper	146364P
black texture	146364B

LIGHT COLOUR

2700K >80CRI 600lm	2
3000K >80CRI 600lm	4
1800-2850K >90CRI 410lm	9

1.0 PAR16

PAR16 max. 35W | GU10 | 100-240VAC | 50-60Hz

CE IP20 0.9m

white texture	146320W0
aluminium brushed	146320L0
gold	146320G0
copper	146320P0
black texture	146320B0

OPTIONAL

for PAR16 lamps see our catalogue

OPTIONAL

single inner cover max. 10W

white texture	911021W1
gold	911021G1
black texture	911021B1

base plate dimensions

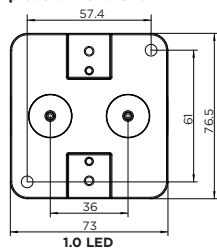

1.0 LED

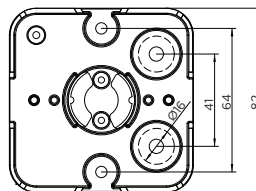

1.0 PAR16

1.0 LED

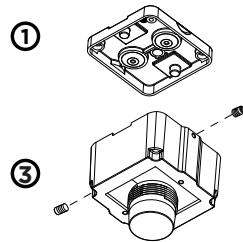

1.0 PAR16

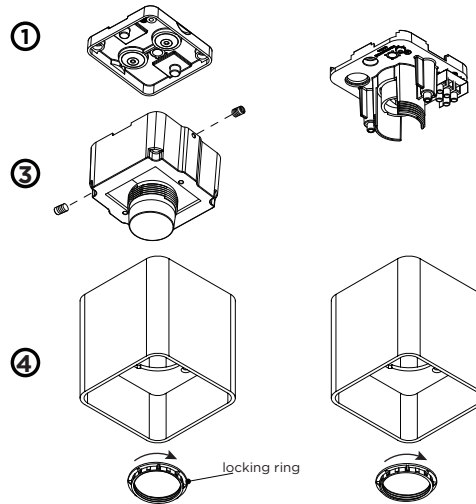

or

or

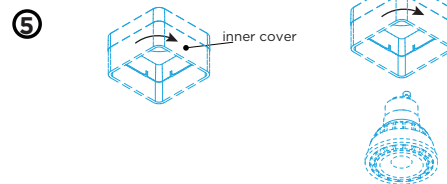

DIMENSIONS

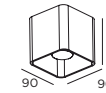

1.0 LED

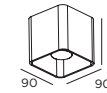

1.0 PAR16

1 MOUNTING INSTRUCTION

Remove the screws of the top part, put the cables through the opening and mount the base on the ceiling.

2 POWER CONNECTION

Connect wiring to the power supply (for LED) or to terminal block (for PAR16)
interior connection: STANDARD version

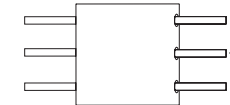

STANDARD

3 FOR LED

Attach the LED housing on the base by two allen screws.

4 FOR LED

Attach the DOCUS cover to the LED housing by screwing the locking ring

FOR PAR16

Attach the DOCUS cover to the base by screwing the locking ring

5 OPTIONAL inner cover

put the inner cover in the outer cover by screwing.

with inner cover: **max. 10W**

when using the inner cover you don't need the locking ring.



WEVER & DUCRÉ
LIGHTING

www.weverducre.com

Wever & Ducre bvba Kwadestraat 153 bus 2.1 8800 Roeselare

INSTALLATION
INSTRUCTIONS