

# DEEP ADJUST 2.0

INSTALLATION INSTRUCTIONS | JUNE 2020

## HOLE DIMENSION

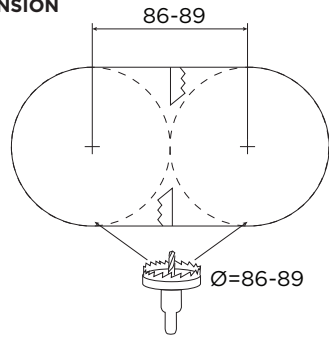

## 2.0 LED

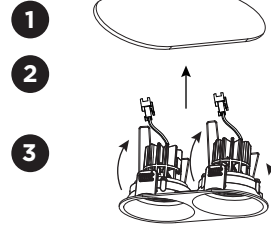

1

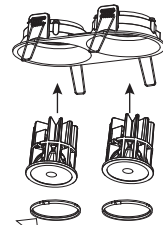

2

3

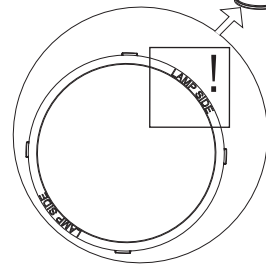
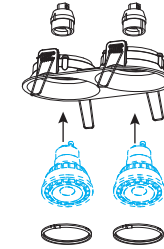
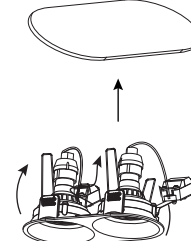

## 2.0 PAR16



  Driver must be powered off before connecting cables.

Before connecting the luminaire/LED module to the driver please make sure the driver is not powered but disconnected from the mains. The driver can only be powered when the luminaire/LED module is already connected. Disregarding this instruction might damage or even destroy the luminaire/LED module.

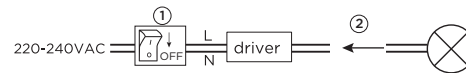

## DIMENSIONS

2.0 LED

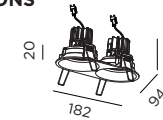

86-89x  
172-178

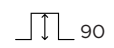

90 4-23

2.0 PAR16

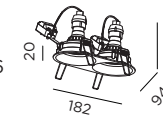

86-89x  
172-178

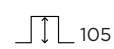

105 4-23

## MOUNTING INSTRUCTION

1 Make a hole in the ceiling according to the prescribed dimensions.

2 POWER CONNECTION

**LED** Always use a driver according to the specifications of the LED module.

### Single connection



### Multiple connection

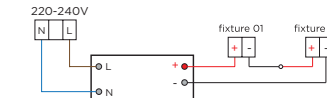

## PAR16

### Single connection

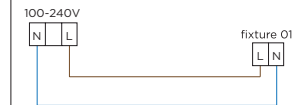

### Multiple connection

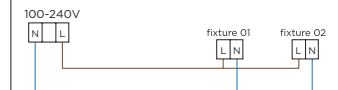

3 Push the springs up and insert the fixture in the ceiling hole.