

Ø100

485

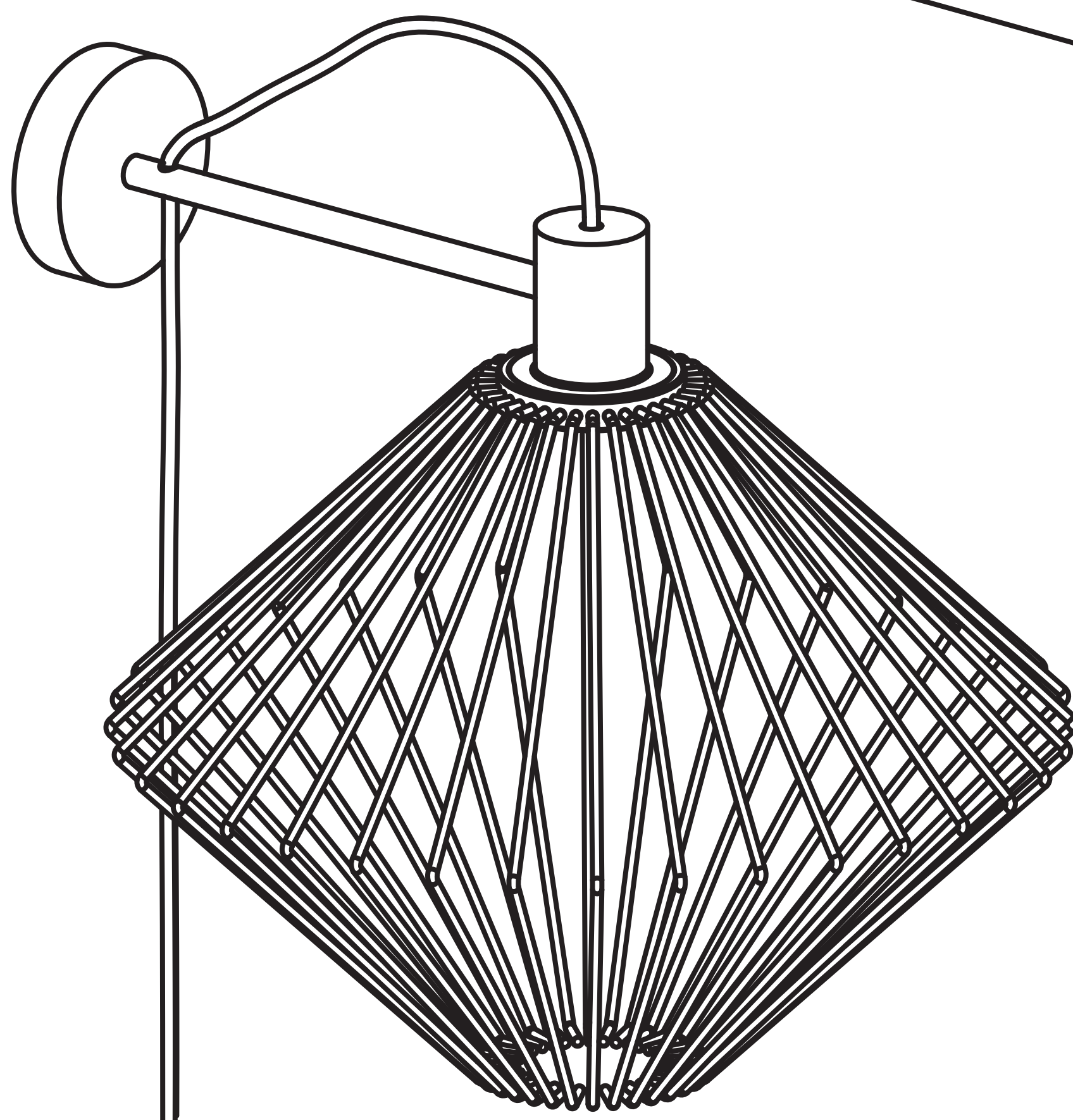

440

Ø415