

Ø300

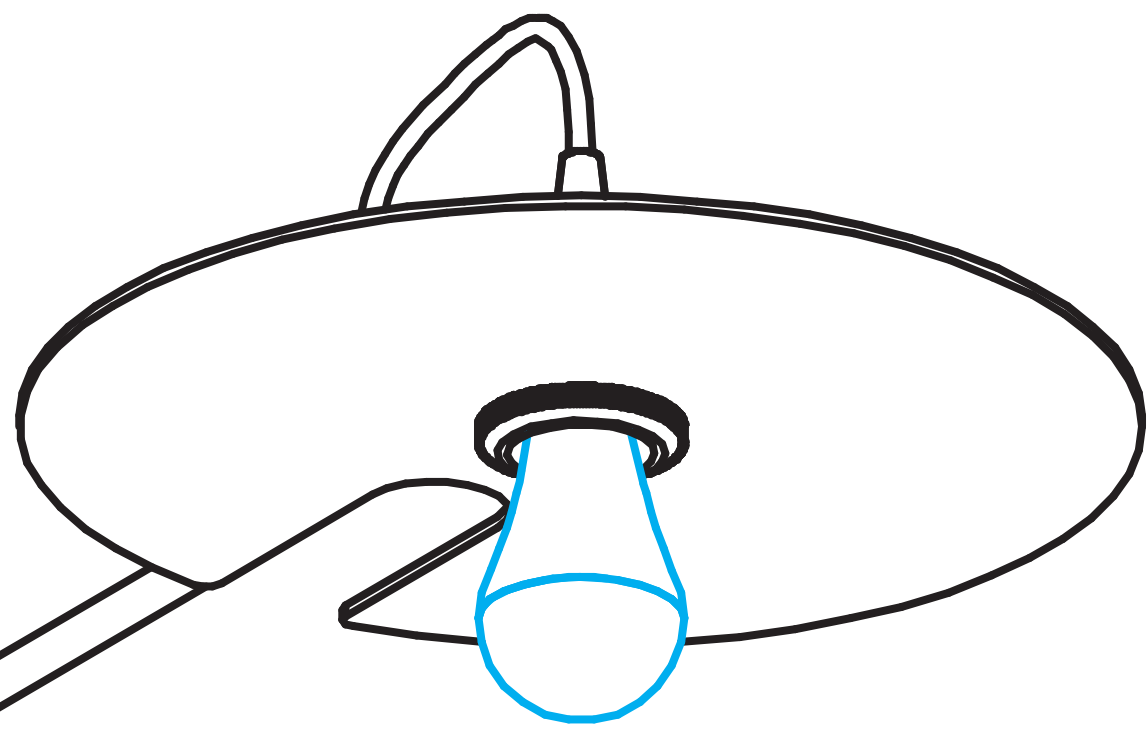

330

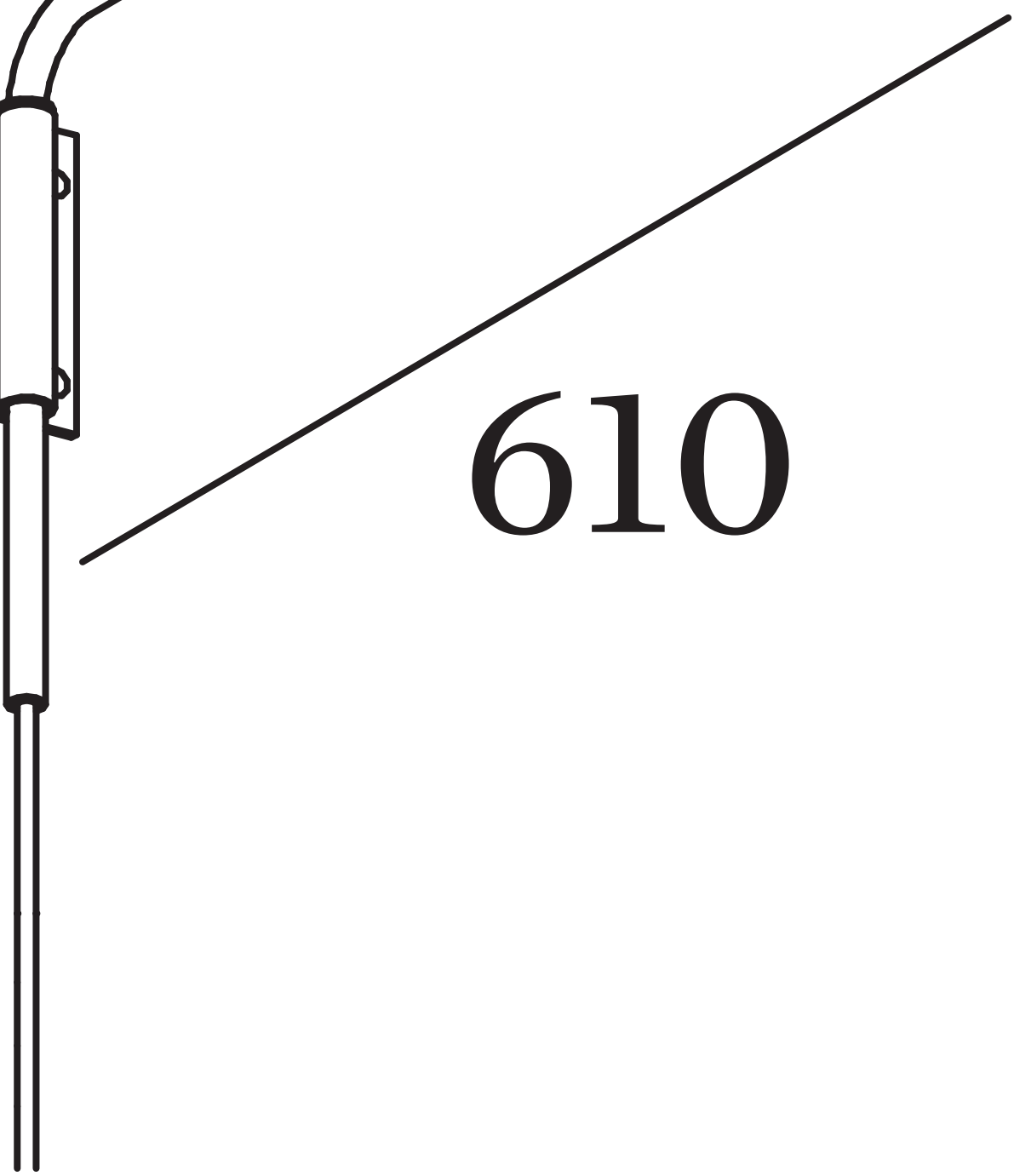

610

