

350

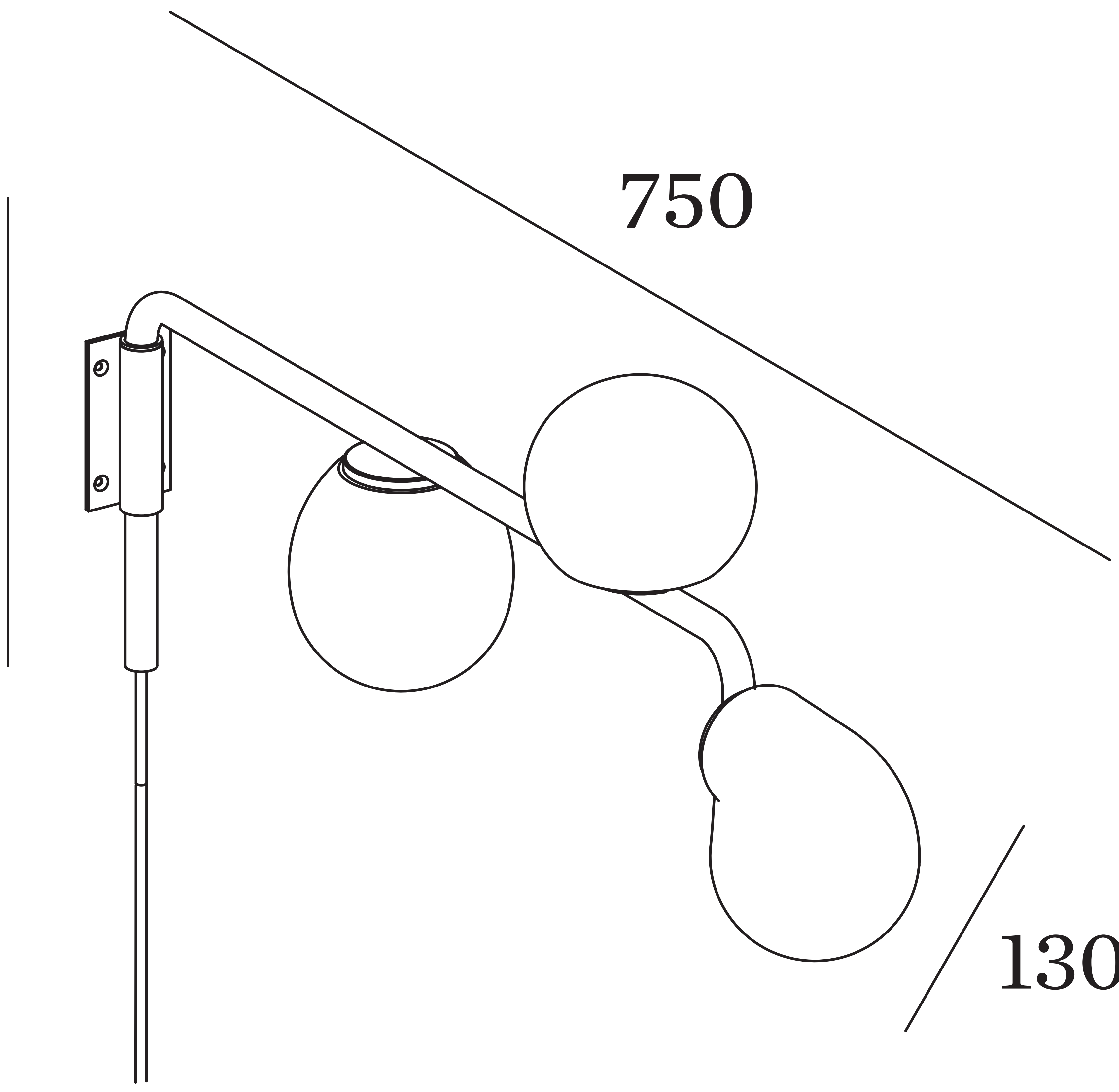

750

130