

571

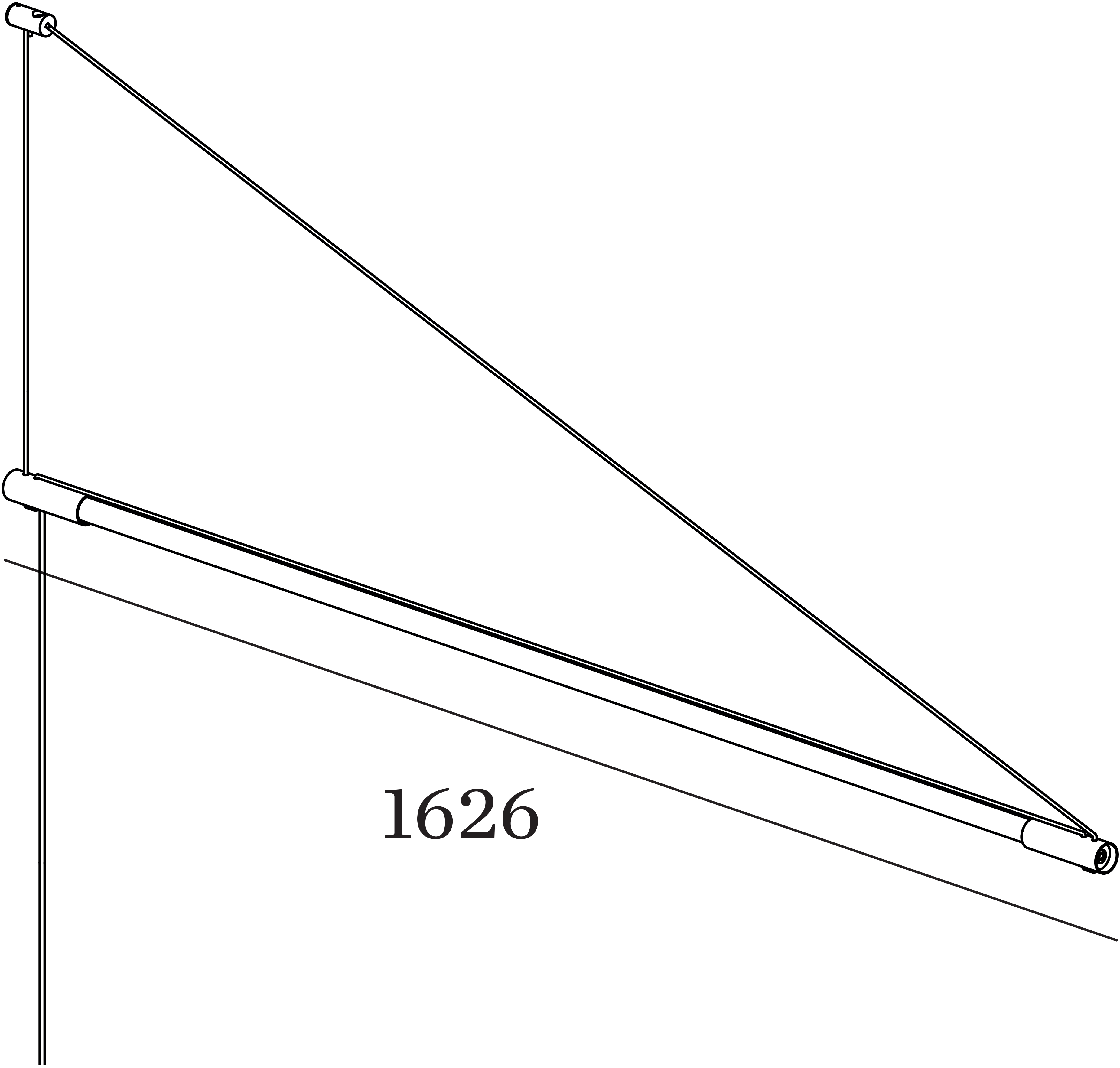

1626



Ø33