

130

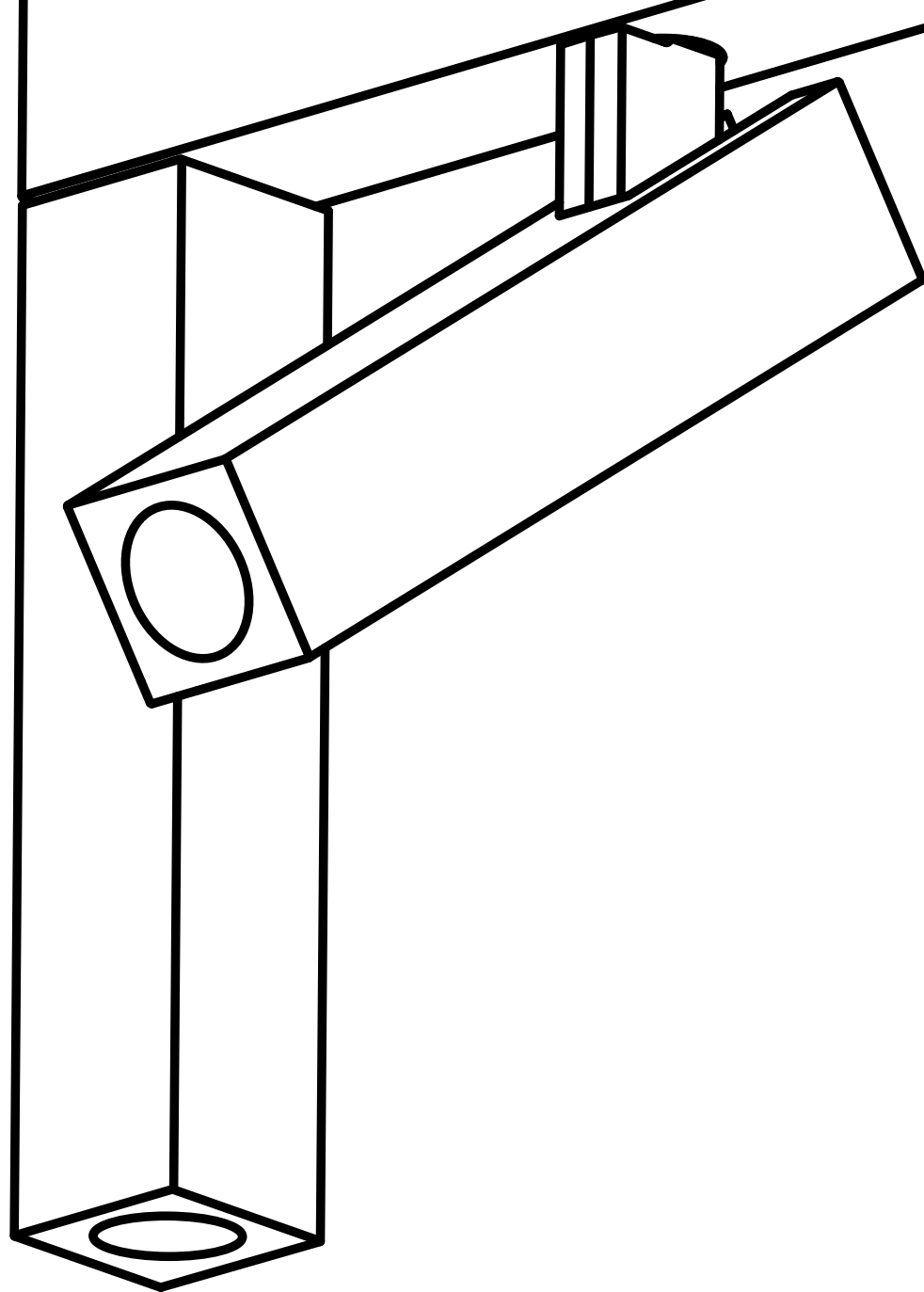

450

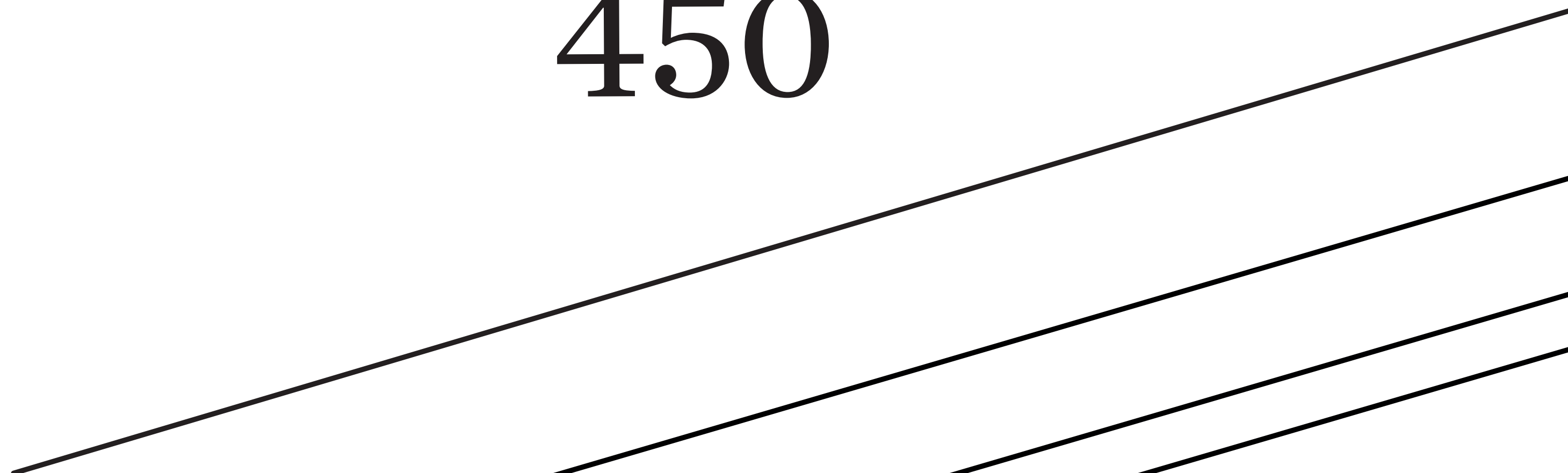

26



26

