

463

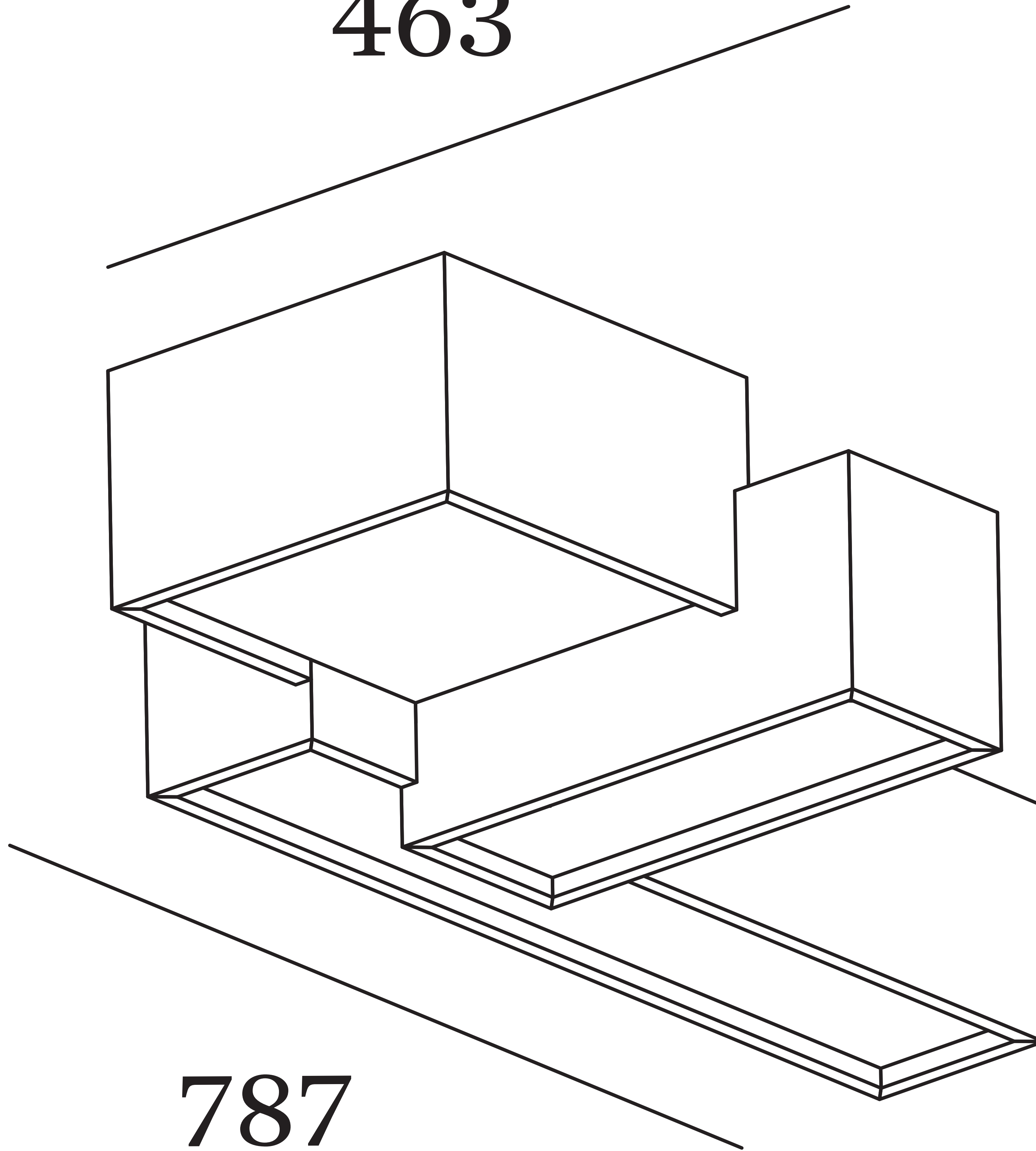

787

270