

30

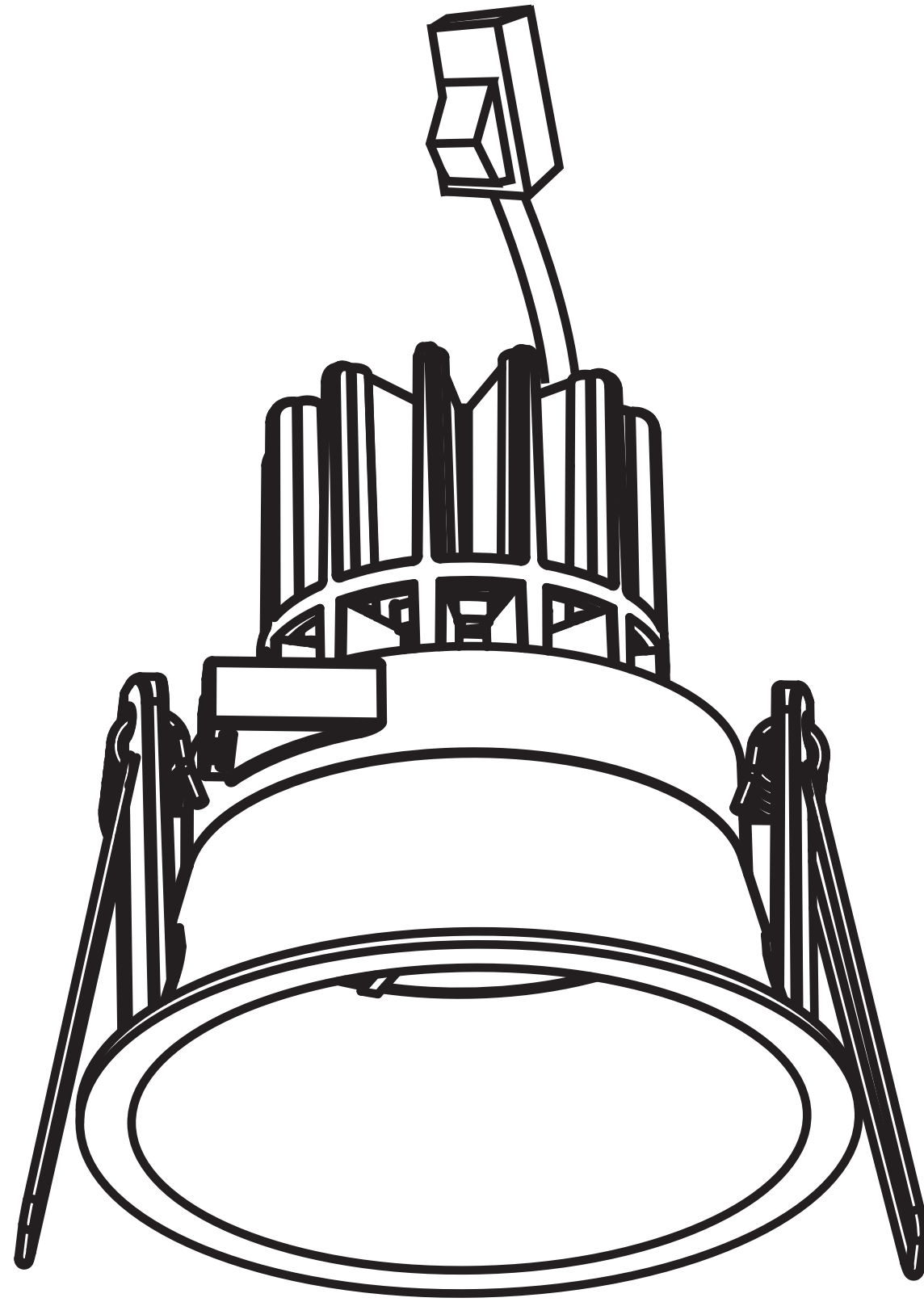

95



Ø85