

Ø135

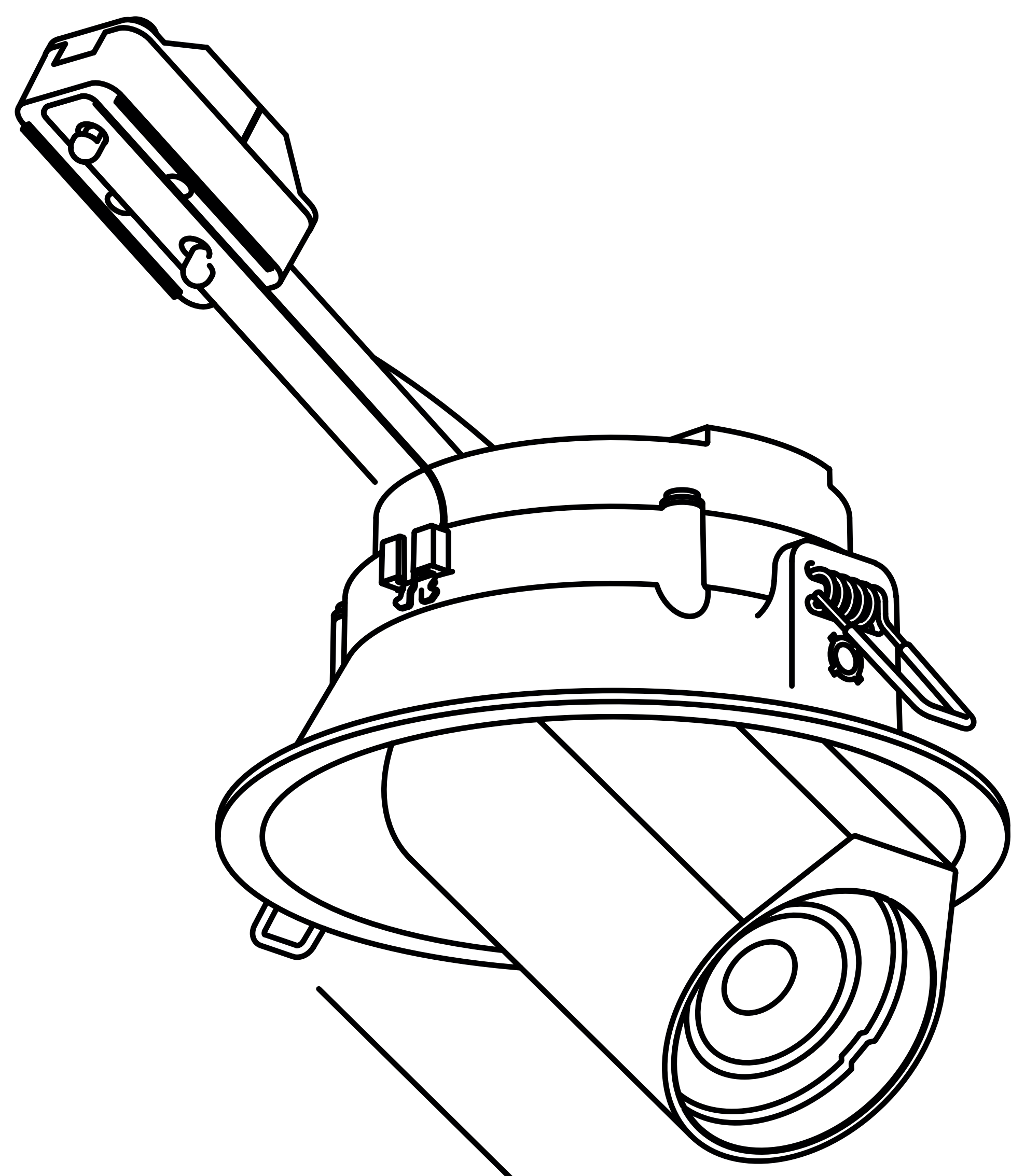

59

96

Ø55