

Ø151

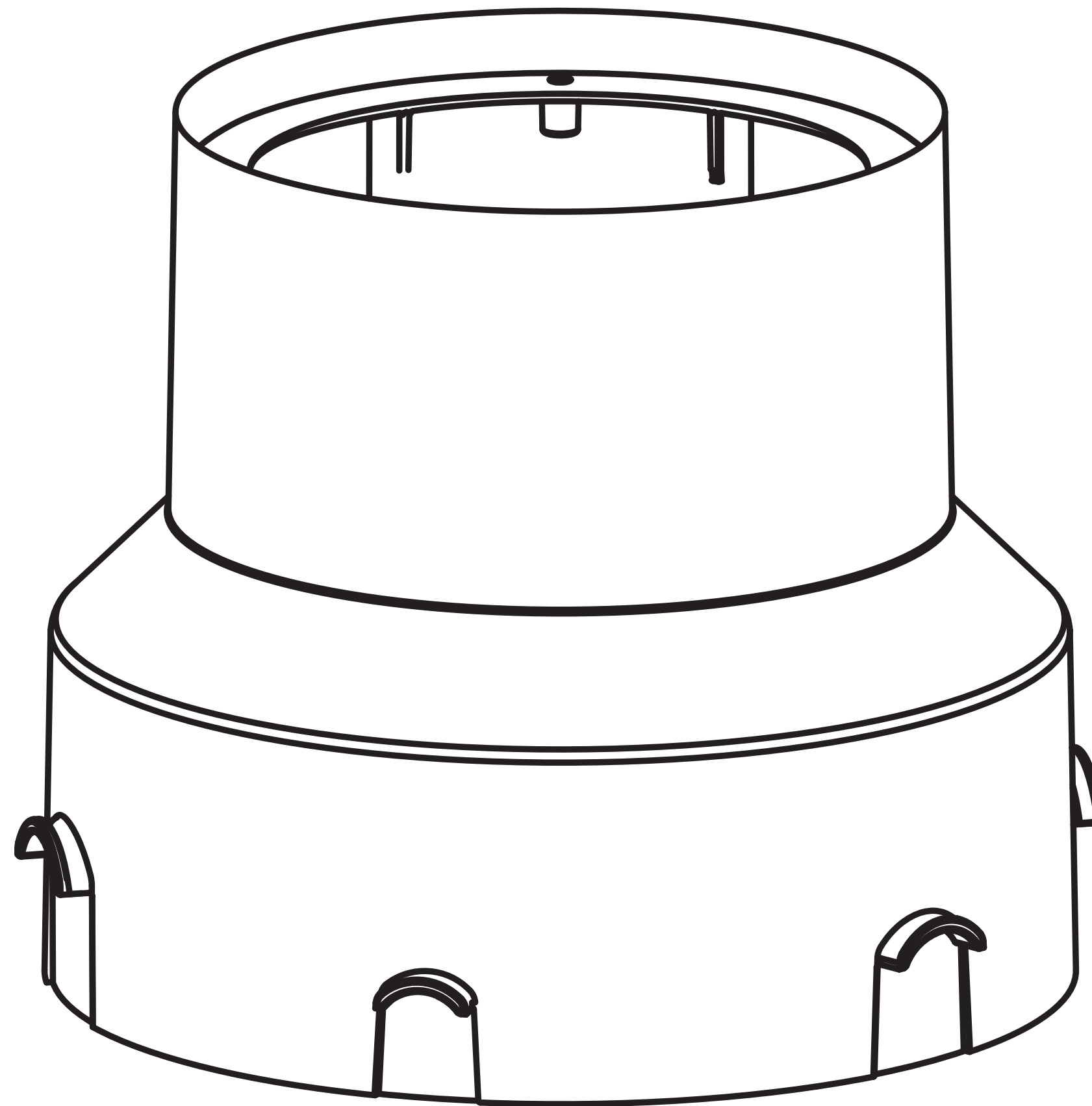

175



Ø213

