

Ø51

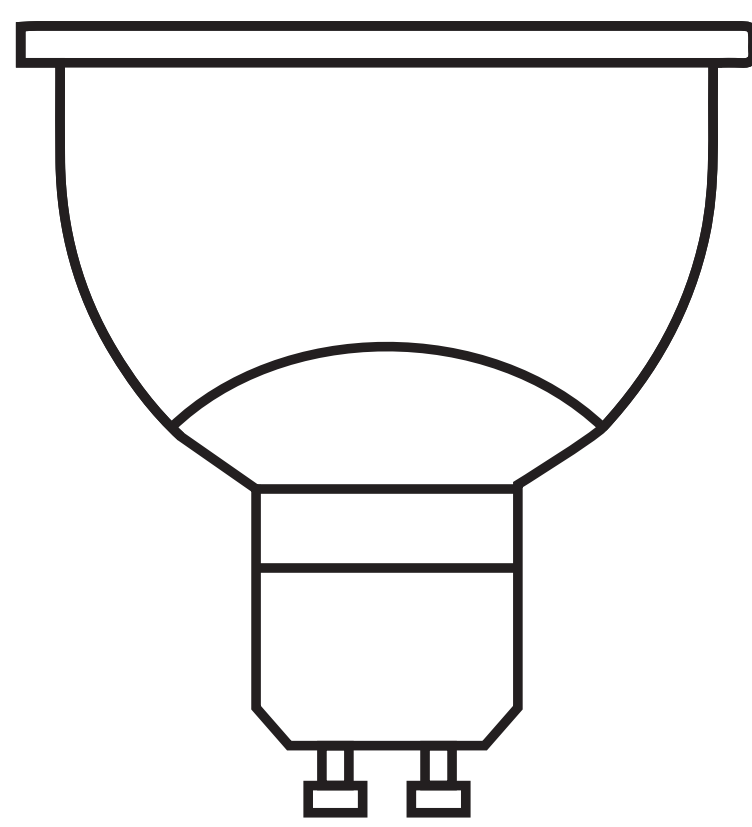

55